



















Number	Picture	QTY
A		4
B		10
C		2
D		6
E		22
F		1
G		2
HGC		20
①		7
②		30
③		32
④		20
⑤		6
⑥		2
⑦		8
⑧		4
⑨		8
⑩		4
⑪	 Cover	1

Step.1



Step.2

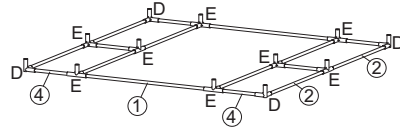
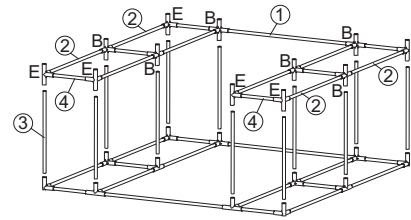

Step.3

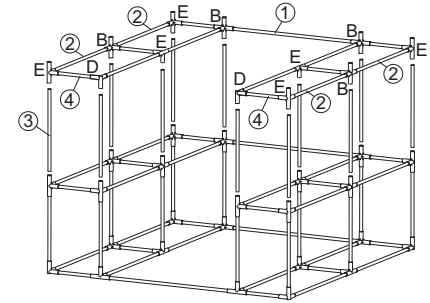

Step.4

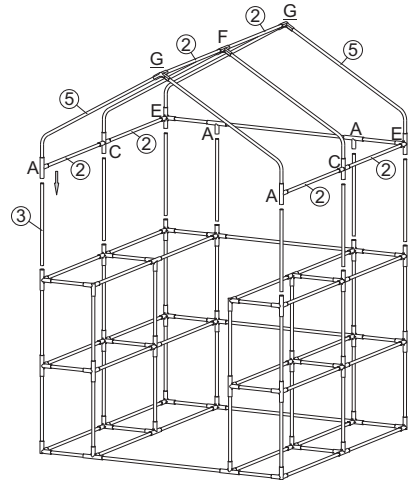

Step.5

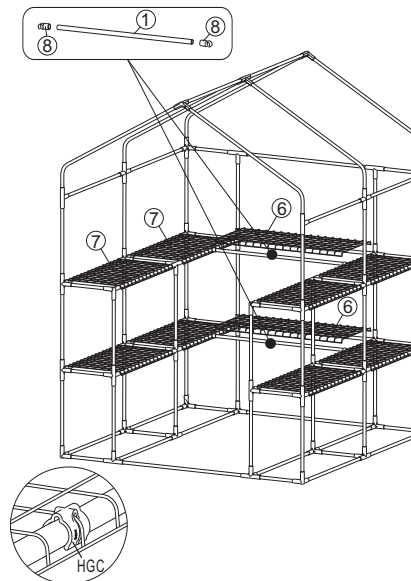

Step.6

